

Drying Accelerator

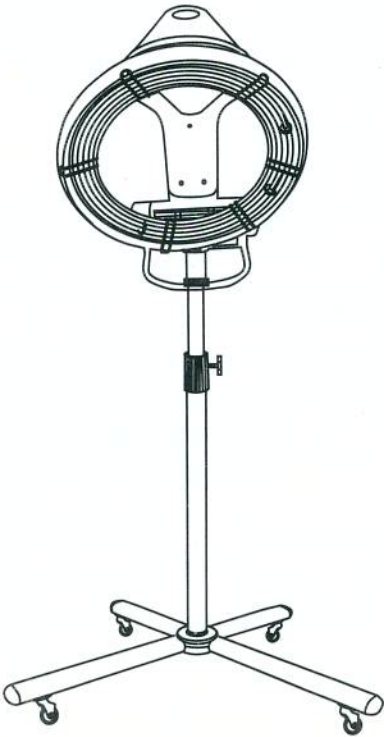

CONTROL PANEL

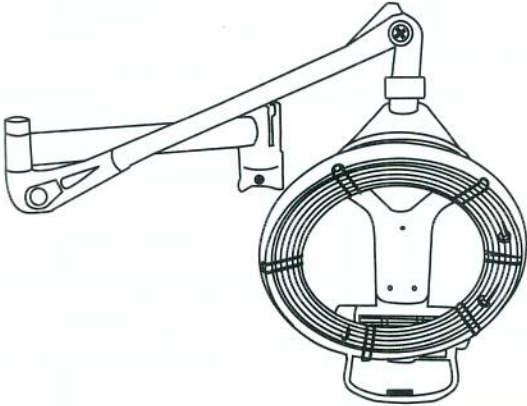
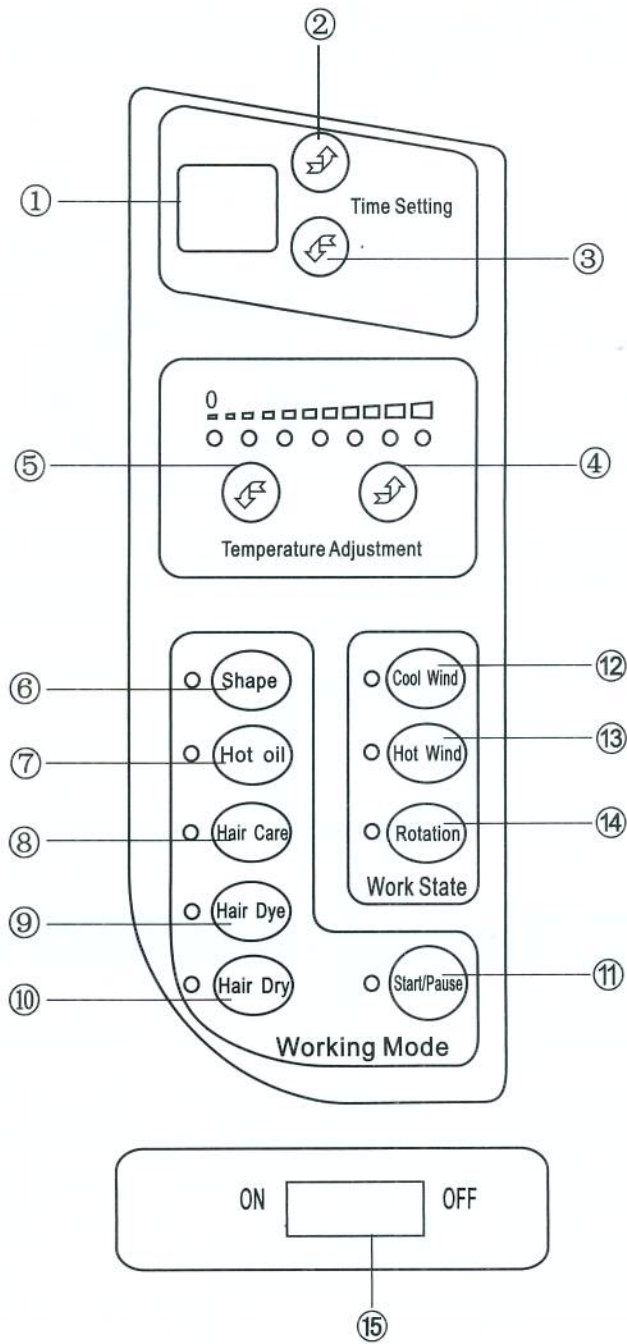

CONTROL PANEL

- ① TIME DISPLAY
- ② TIME INCREASMENT
Press once, then time increases a minute. In the case of press and hold then time increases continuously as long as to 60 minutes.
- ③ TIME DECREASMENT
Press once, then time decreases a minute. In the case of press and hold then time decreases continuously as short as to 01 minutes.
- ④ TEMPERATURE INCREASMENT
Press once, then temperature increases a level.
- ⑤ TEMPERATURE DECREASMENT
Press once, then temperature decreases a level.
- ⑥ -- ⑩ FUNCTION SELECTIONS:
Can be selected from five functions, includes Shape, Hot oil, Hair Care Hair Dye, and Hair Dry
- ⑪ STOP/START
Press once to start operation, press again to pause the operation.
- ⑫ COOL WIND
This key controls the fan behind neck position, from on to off.
- ⑬ HOT WIND
This key provides selection from cool to hot wind.
- ⑭ ROTATION
It controls the circular heating element from going around to being still.
- ⑮ MAIN POWER SWITCH
It switches the machine's main power supply. Please turn off if the machine is not in-use.

FUNCTION

Except in Manual operation, the circular heating element shall rotate in a specific way under normal circumstances. It produces set temperature, and spread heat evenly, providing relaxing, soft, comfortable, and warm experiences for consumers. Functions can be selected to provide heat to specific place, in order to provide options such as: Styling, Oil treatment, and Drying.

Operation modes---Application and operation status

Mode	Application	Operation Status				
		Temperature	Time (min)	Fan	Hot wind	Rotation
Shape	Please adjust time and temperature according to type of hair, specification of products used and technical requirement.	2	28	Off	Off	On
		May operate under manual mode if requires.				
Hot oil	Please adjust time and temperature according to type of skin, specification of products used and technical requirement.	4	20	Off	Off	On
		May operate under manual mode if requires.				
Hair Care	Adjust time and temperature according to type of hair and type of shampoo.	3	15	Off	Off	On
		May operate under manual mode if requires.				
Hair Dye	In use with partially styling and acid type coloring products.	5	08	Off	Off	On
		May operate under manual mode if requires.				
Hair Dry	Selected when drying ordinary natural hair.	4	13	On	On	On
		May operate under manual mode if requires.				

OPERATING MANUAL

1. Plug the machine to wall power supply, then turn the MAIN POWER SWITCH on :
 - * When "00" is displayed on the time display window, it means that the machine is ready for operation.
 - * When the circular heating element is not in its initial position, it will return to its default place.
2. **Operating procedure:**
 - * Choose the function that you need, and then indicators will light up beside chosen functions.
 - * Press STOP/START button to start the operation.
 - * The circular heating element shall operate under chosen operating option.
 - * Time and temperature can be adjusted if required.
3. **During operation:**
 - * Indicator beside STOP/START key shall keep lighting up.
 - * Indicator beside chosen operation shall keep lighting up.
 - * Decimal point in the TIME DISPLAY window shall flash every second.
 - * All operating modes can be switched from one to another during operation.
4. **Pause operation:**
 - * Press STOP/START to pause the operation, now the indicator beside STOP/START key shall be lighted up.
 - * The circular heating element will stop rotating.
 - * Mode and status indicator shall keep lighting up.
 - * Temperature and time can be adjusted.
 - * All operating modes can be switched from one to another after pausing operation.
5. **Cut off timer:**
 - * In the case when preset time is up, buzzer would buzz for five times, indicates that operation is finished.
 - * If the circular heating element is not at its initial position, please turn the machine off then on, and the heating element would return to its default position.
 - * Please unplug the machine after use.

Setting illustration

Step one:



1. Setting height by adjusting the supporting tube, in order to place the rubber piece behind client's neck.
2. Keep the rubber piece about 5cm away from the back of client's neck.
3. If the wall version is used, please do hold the metal mount of the machine in re-positioning. Never grip the circular heating element to move the machine.

Step two:

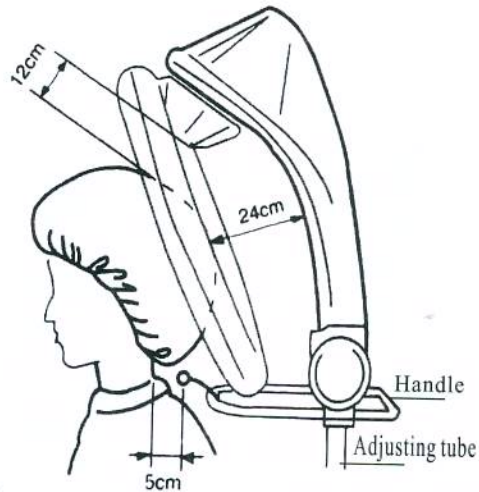

1. Between the top point of client's head and machine's rotation centre, a 12cm distance shall be reserved.
2. Keep the rubber piece about 5cm away from the back of client's neck.

Step three:

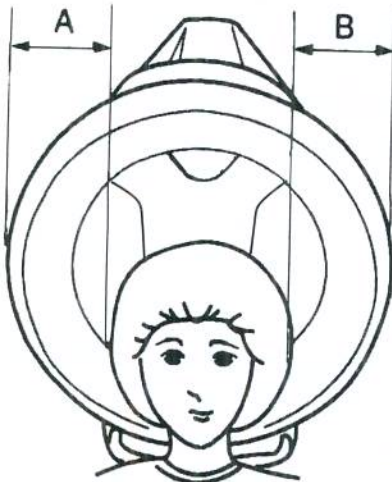

Keep distance A and B the same (as shown above), in order to have client in the middle of the machine.

Step four:

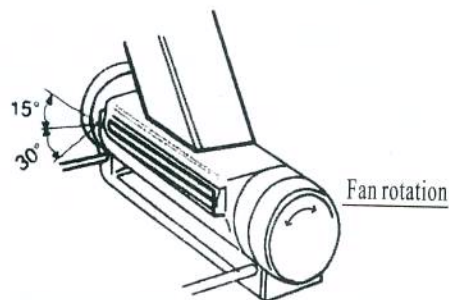

According to the length of client's hair, the angle of the fan behind the neck could be adjusted. Rotate the adjusting cover to observe changes from up 15-degree, down 30-degree from water level position.

INSTALLATION OF SWING ARM

一、 First, Pre-check before installing the wall swing-arm:

① Wall

Please ensure the wall is well-build and sufficient to carry the force and load from the machine.

② Height

As illustrated from the picture below, the hanger is recommended to be installed between 1850-2000mm above ground.

③ Power supply

There shall be wall plug (220V/50Hz) within 500mm radius of the machine.

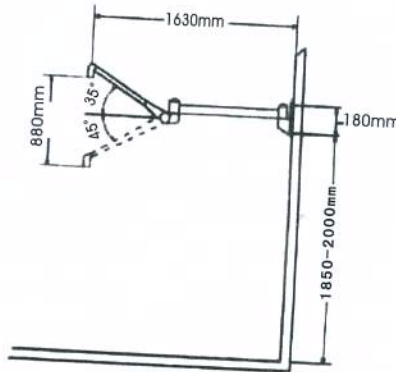

Ills.1

二、 Second, Installation of the wall-arm-adaptor

① Drill holes with 10.5mm diameter, 65mm depth, on the wall, using the wall-arm-adaptor as a template.

② Insert cavity into the hole, tighten it up with a nut, make sure the cavity is in the hole properly.

③ Place the wall-arm-adaptor onto the cavities. Place in order washer, then spring washer, finally lock down by tighten nut to it.

Caution: Because the wall-arm-adaptor has to carry the load of the whole machine and the swing-arm., as a result, please ensure the installation is accurate and firm, preventing the machine from falling down.

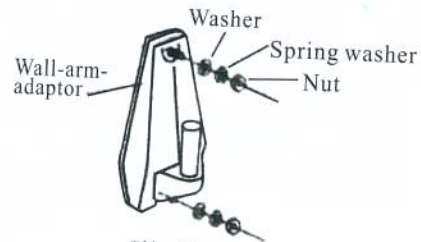

Ills.2

三、 Thirdly, installation of swing-arm and machine.

- ① Place one end of the swing-arm onto the wall-arm-adaptor (shown in ill.3)
- ② Unscrew the secure-screw, place the covering-ring onto the perpendicular tube, then insert the hanging connector into the perpendicular tube, and line up the groove on the connector to the hole on the tube, finally, put four metal balls into the hole and pull the covering-ring down on top of those metal balls.
- ③ Do the secure-screw up, and then plug the cable to wall power supply.



Ills.3

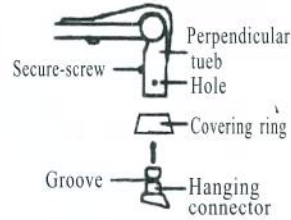

Ills.4

四、 Fourthly, adjusting the swing-arm

- (1) (1) Maximum height setting: in the case when the machine hits ceiling or other furniture, max. height position may be limited in the following way.
 - ① Loosen the nut indicated with an open-ended spanner. Turn the position-setting screw anti-clockwise to drop the height or clockwise to raise height.
 - ② Tighten the nut once desire height was set.
- (2) Perpendicularity adjustment: Perpendicularity can be adjusted if the perpendicular tube is not in its position, once the machine had been attached to the swing-arm, please follow instruction below.

- ① As illustrated in ill.5, undo the screw and detach the plastic cover. Alter perpendicularity using an open-ended spanner.
- ② Attach the plastic cover after position confirmed.

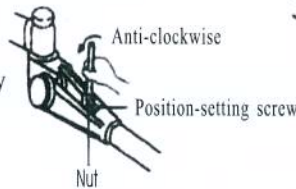

Ills.5

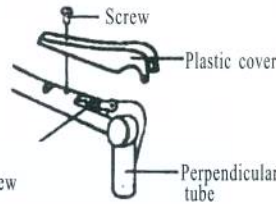

Ills.6

- (3) Weight balancing adjustment: in the case when the machine cannot be set to a specific position, adjustment process can be made as follows:
As in ill.6, detach the plastic cover, pole the stick provided into the balance adjusting nut and rotate. Pull the machine down and let go, if it rises, please loose the nut in order to loose the spring; if it falls, please tight the nut in order to have tighter spring. Assemble the plastic cover after adjustment.



Ills.7

INSTALLATION OF STAND/BASE

- Standing version:** 1) Assemble the stand as illustrated in ills.8
 2) Place the machine onto the stand, and adjust it to desire height.

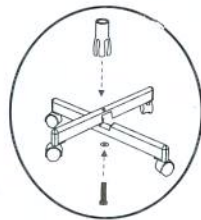

Type 1

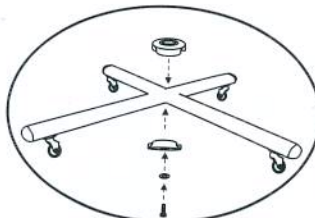

Type 2

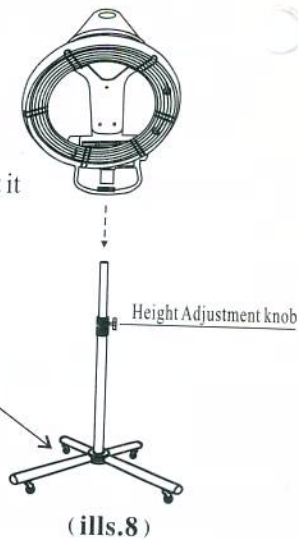

Caution:

- 1) Do not touch the surface or the safety net on the circular heating element, in order to prevent being burnt, as tremendous heat would be produced during operation
- 2) An earth wire must be connected to the wall power supply, thus, the machine has to be earthed.
- 3) Machine must be serviced or repaired by a certified technician or technician from our authorized dealer. Repaired machine must be fully inspected in order to meet safety standards before reused.
- 4) In the case when the wire is damaged or aged, new 53 (RVV) 3*0.75mm² wire must be replaced by a certified technician or technician from our authorized dealer.

Trouble shooting:

Status	Reason	Solution
Circular heating element does not rotate at all.	1, Rotation function was not chosen. 2, Faulty motor. 3, Connector between motor and rotor became looses.	1, Press the ROTATION key. 2, Replace the motor. 3, Open the back-cover then tight the connector.
Circular heating element dose not rotate regularly.	1, Connector between motor and rotor became looses. 2, Faulty motor. 3, Motor cannot be stopped.	1, Open the back-cover then tight the connector. 2, Replace the motor. 3, Replace the optical sensor or the positioning strip.
Heating element does not produce heat..	1, Heating function was not chosen. 2, Heating element or relay is faulty. 3, Connector between motor and rotor became looses.	1, Adjust temperature to non-zero status. 2, Replace heating element or power relay. 3, Open the back-cover then tight the connector.