

# precious

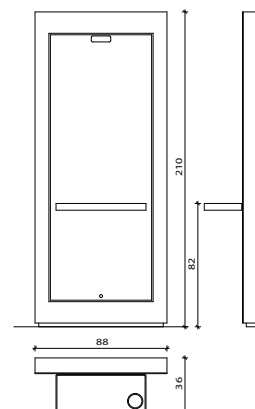

# shelves

## COMBINATIONS

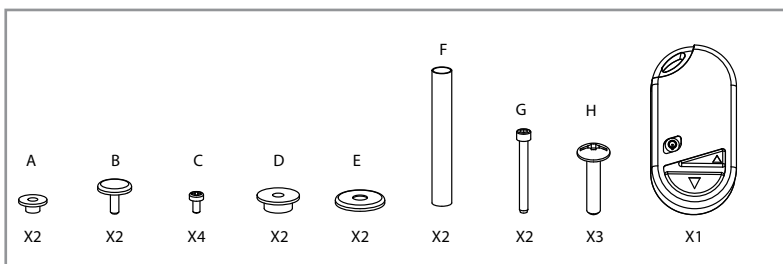
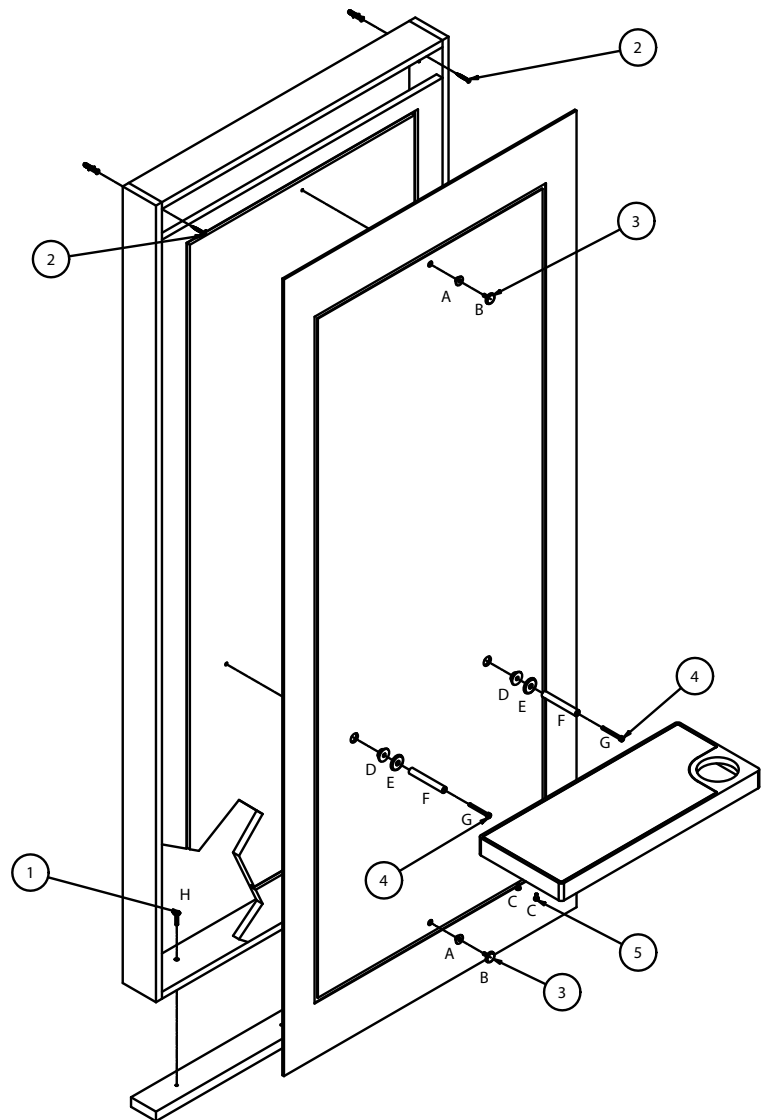
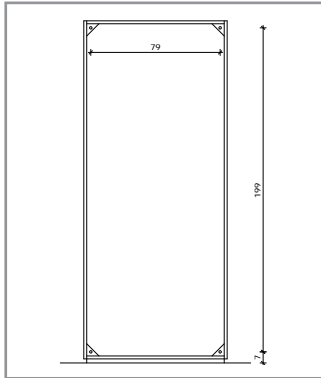
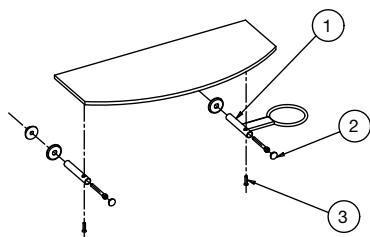

**GLASS -01**

SCARLET	MI/010
LISBOA	MI/020 - MI/025
FIJI	MI/030
LYON	MI/050 - MI/052
SANTIAGO	MI/060 - MI/062
BARCELONA	MI/070 - MI/072 - MI/080
PLATINUM	MI/150
PARIS	MI/230
STYLOS	MI/260 - MI/261 - MI/262 - MI/263
PRECIOS	MI/320
NEW MOON	MI/350

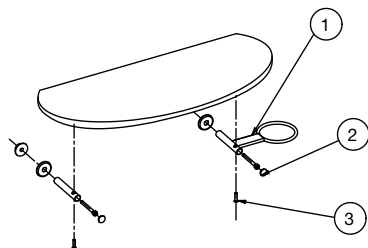

**BLACK  
GLASS -02**

SCARLET	MI/010
LISBOA	MI/020 - MI/025
FIJI	MI/030
LYON	MI/050 - MI/052
SANTIAGO	MI/060 - MI/062
BARCELONA	MI/070 - MI/072 - MI/080
PLATINUM	MI/150
PARIS	MI/230
STYLOS	MI/260 - MI/261 - MI/262 - MI/263
PRECIOS	MI/320
NEW MOON	MI/350

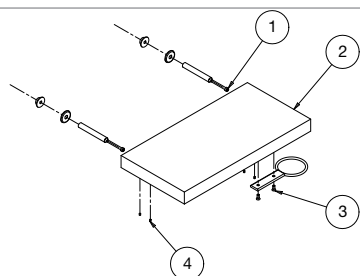

**WENGE  
WOOD -04**

SCARLET	MI/010
LISBOA	MI/020 - MI/025
FIJI	MI/030
LYON	MI/050 - MI/052
SANTIAGO	MI/060 - MI/062
BARCELONA	MI/070 - MI/072 - MI/080
TOTEM	MI/130
PLATINUM	MI/150
PARIS	MI/230
STYLOS	MI/260 - MI/261 - MI/262 - MI/263
PRECIOS	MI/320
NEW MOON	MI/350

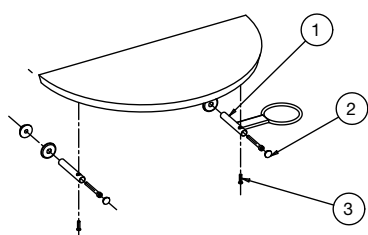

**ROUND  
ALUMINIUM -05**

SCARLET	MI/010
LISBOA	MI/020 - MI/025
FIJI	MI/030
LYON	MI/050 - MI/052
SANTIAGO	MI/060 - MI/062
BARCELONA	MI/070 - MI/072 - MI/080
PLATINUM	MI/150
PARIS	MI/230
STYLOS	MI/260 - MI/261 - MI/262 - MI/263
PRECIOS	MI/320
NEW MOON	MI/350

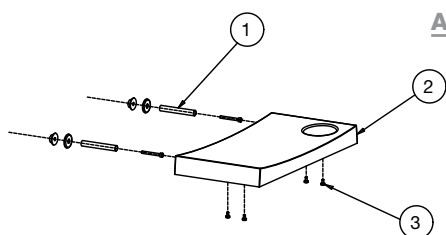

**ALUMINIUM -06**

SCARLET	MI/010
LISBOA	MI/020 - MI/025
FIJI	MI/030
LYON	MI/050 - MI/052
SANTIAGO	MI/060 - MI/062
BARCELONA	MI/070 - MI/072 - MI/080
TITANIUM	MI/140
PLATINUM	MI/150
PARIS	MI/230
STYLOS	MI/260 - MI/261 - MI/262 - MI/263
PRECIOS	MI/320
NEW MOON	MI/350

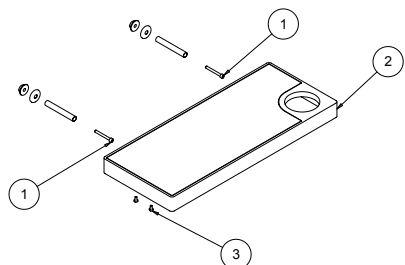

**ALUMINIUM  
+ MIRROR -07**

LISBOA	MI/020 - MI/025
FIJI	MI/030
LYON	MI/050 - MI/052
SANTIAGO	MI/060 - MI/062
BARCELONA	MI/070 - MI/072 - MI/080
PLATINUM	MI/150
PARIS	MI/230
STYLOS	MI/260 - MI/261 - MI/262 - MI/263
PRECIOS	MI/320
NEW MOON	MI/350

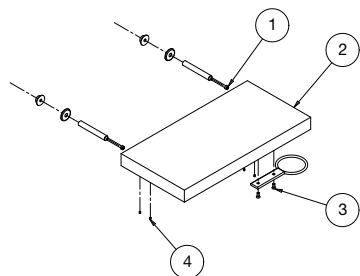

**ELMWOOD -08**

SCARLET	MI/010
LISBOA	MI/020 - MI/025
FIJI	MI/030
LYON	MI/050 - MI/052
SANTIAGO	MI/060 - MI/062
BARCELONA	MI/070 - MI/072 - MI/080
PLATINUM	MI/150
PARIS	MI/230
STYLOS	MI/260 - MI/261 - MI/262 - MI/263
PRECIOS	MI/320
NEW MOON	MI/350